

## Oferta handlowa 2017 r.

### Zakład Produkcyjno-Handlowy EKO Luiza Kwiek-Klepcka

**Adres:**

ul. Szklarniowa 38  
33-111 Koszyce Wielkie

[www.ekokwiek.pl](http://www.ekokwiek.pl)

**Kontakt:**

tel./faks (14)634-05-54  
tel. kom. 602619192

e-mail: [biuro@ekokwiek.pl](mailto:biuro@ekokwiek.pl)

# klocki hamulcowe – maszyny budowlane, maszyny rolnicze

## Zastosowanie:

- maszyny budowlane
- maszyny rolnicze
- maszyny górnicze

## Materiał:

- EKO, SACF

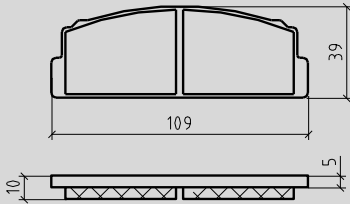
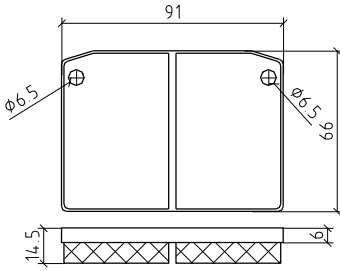
L.p.	Nazwa Nr kat.	Schemat	Przykładowe zastosowanie
1.	wkładka cierna nr kat. W0001 325-01-1347	 <p>Wymiary [mm] 109 x 39 x 10</p>	<ul style="list-style-type: none"> <li>- Wkładka do hamulca ręcznego ładowarka Ł-34 HSW</li> <li>-Dressta</li> <li>- Toyota – wózki widłowe różnego typu</li> </ul>
2.	wkładka cierna nr kat. W0002 N2016	 <p>Wymiary [mm] 91 x 66 x 14,5</p>	<ul style="list-style-type: none"> <li>- Wkładka do hamulca ręcznego ładowarka Ł-35 HSW</li> <li>-Dressta</li> <li>- dźwigi - Coles</li> <li>- ładowarki - Weatherill L61DII</li> </ul>

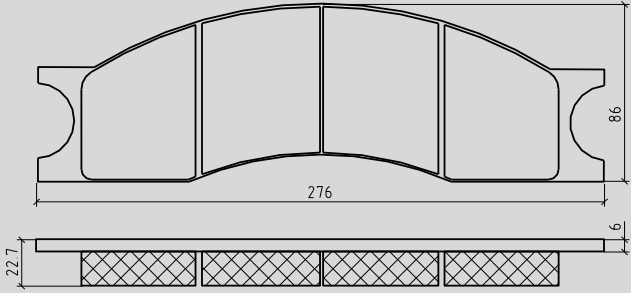
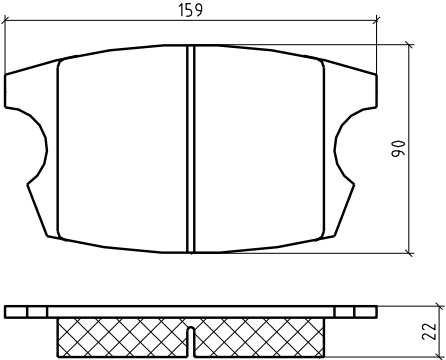
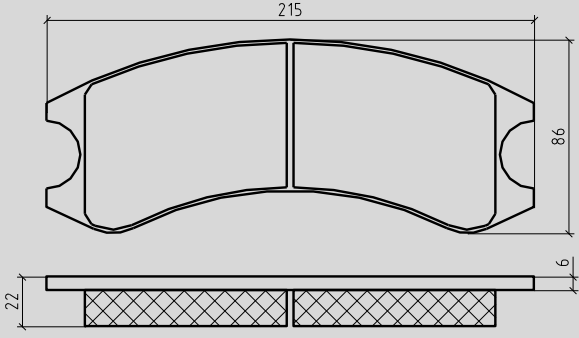
3.	<p>wkładka cierna nr kat. W0003</p> <p>244-765 244-440 244-214 854-04-0441 8R0821 2V9135 7K5059 7K5057 840611 15050418 S301464 11991355 11992696</p>	 <p style="text-align: center;"><b>Wymiary [mm]</b> 276 x 86 x 22,7</p>	<ul style="list-style-type: none"> <li>- Aveling Barford</li> <li>- Case W14,W18, W20, W24</li> <li>- Caterpillar 250, 930, 950</li> <li>- Clark-Michigan 45, 50, 75, 125, 175</li> <li>- DJB M25/653, M25/673</li> <li>- Faun FK20, FK1000</li> <li>- Fiat Allis</li> <li>- IHC</li> <li>- JCB 413, 418, 423, 427, 428</li> <li>- Kawasaki KSS70 Scraper</li> <li>- Terex</li> <li>- Furukawa FL230, FL330</li> <li>- Volvo BM LM218</li> </ul> <p>ładowarki:</p> <ul style="list-style-type: none"> <li>- Fadroma ŁK1, ŁK1A, ŁK2, ŁK2N. Ł220, Ł230, Ł240, Ł260</li> <li>- HSW Ł34, Ł34B, Ł35</li> <li>- XCMG: ZL50G, ZL30G, XZ636, XZ656, XG955, XG932</li> </ul> <p>Ciągniki: – LKT (Czechy)</p>
4.	<p>wkładka cierna nr kat. W0008</p>	 <p style="text-align: center;"><b>Wymiary [mm]</b> 159 x 90 x 22</p>	<p>- Wkładka hamulcowa wykorzystywana w przemyśle górniczym</p>
5.	<p>wkładka cierna nr kat. W0023</p>	 <p style="text-align: center;"><b>Wymiary [mm]</b> 215 x 86 x 22</p>	<p>- Wkładka hamulcowa wykorzystywana w przemyśle górniczym (unimex – Legnica)</p>

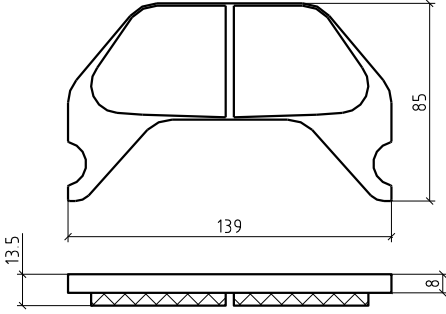
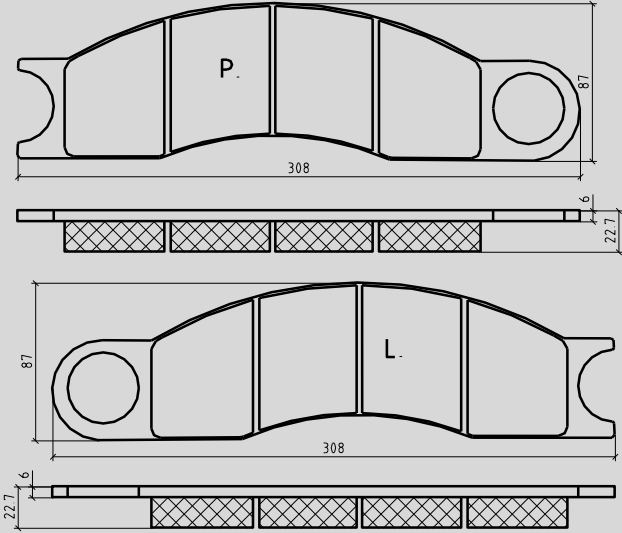
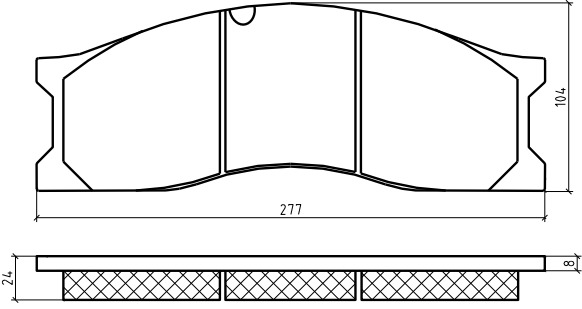
6.	<p>wkładka ciarna nr kat. W0026</p>	 <p style="text-align: center;"><b>Wymiary [mm]</b> 139 x 85 x 13.5</p>	<p>- Wkładka do hamulca ręcznego Przemysł górniczy – HRW (zacisk WABCO)</p>
7.	<p>wkładka ciarna prawa, lewa nr kat. W0035 244-UN-001</p>	 <p style="text-align: center;"><b>Wymiary [mm]</b> 308 x 87 x 22,7</p>	<p>- Wkładka hamulcowa Ładowarka: HSW Ł-34 – nowy typ, 534E -Dressta -Fadroma Ł2, Ł200, Ł201, Ł201A, Ł220, ŁK1</p>
8.	<p>wkładka ciarna nr kat. W0039</p> <p>52157 6213353 6630406 11709042 11990101 11994540 11998758 AU-9050 11035227</p>	 <p style="text-align: center;"><b>Wymiary [mm]</b> 277 x 104 x 24</p>	<p>Volvo: 4300B, 4400, 4500, 4600, 4600B, 5350B, 6300, 861, A20, A20C, A20C BM, A25 BM, A25B, A25C, A25C BM, A25D, A25E, A30 BM, A30C, A30C BM, A30D, A30E, EL70 BM, EL70C BM, L70, L90, L90B BM, L120, L120B BM, L160</p> <p>- Aveling Barford - Bell AU-9050 - Fiat-Hitachi, Werklust - Wozidło AP-30, - Terex , - Haulamatic - Werklust</p>

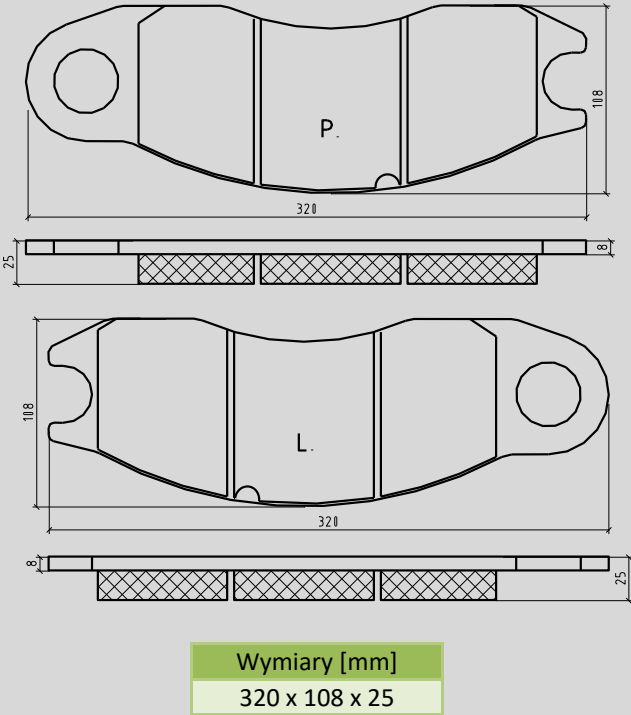
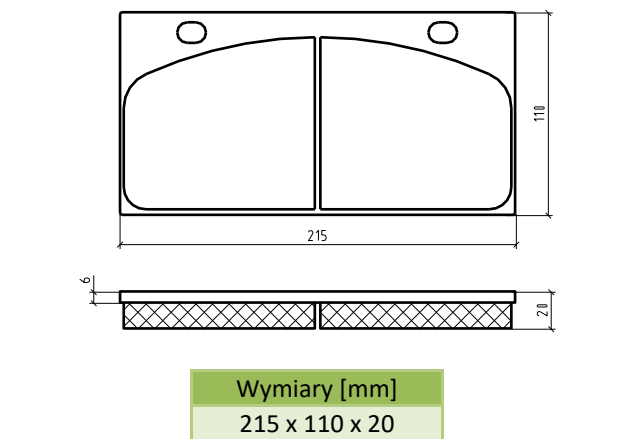
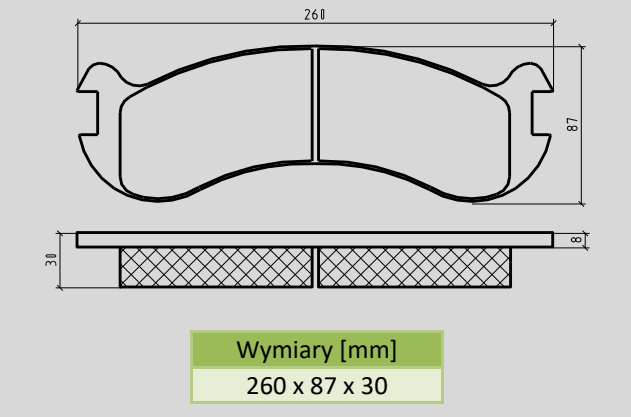
<p>9.</p>	<p>wkładka cierna prawa, lewa</p> <p>nr kat. W0040</p> <p>15265398 4V8416 9C8021 15191826 15191829 12968246 10/300477 60830032 17218536 S301668 244-741-1 244-741 328-7834 15274357</p>	 <p>Wymiary [mm] 320 x 108 x 25</p>	<ul style="list-style-type: none"> <li>- Case 916, 920, 926, 926E, 930</li> <li>- Michigan</li> <li>- Astra</li> <li>- JCB 722</li> <li>- Volvo A25F, A30F</li> <li>- Terex TA30, TA27, TA25, 3066C</li> <li>- Caterpillar 71H, 75J, 62K, 57Z, 41K, 73U IT18, IT18B, IT28B 916, 920, 926, 926E, 930</li> </ul>
<p>10.</p>	<p>wkładka cierna</p> <p>nr kat. W0041</p>	 <p>Wymiary [mm] 215 x 110 x 20</p>	<ul style="list-style-type: none"> <li>- ładowarka: YTO ZL50 XCMG</li> <li>- Shantui SL60W</li> <li>- XG951, XG850, XG855</li> </ul>
<p>11.</p>	<p>wkładka cierna</p> <p>nr kat. W0042</p> <p>244-547 9396789 410-2201 414-6011 11992515 220135 (Bell) 244-2516 244W751 561-34-61110</p>	 <p>Wymiary [mm] 260 x 87 x 30</p>	<ul style="list-style-type: none"> <li>- Bell</li> <li>- Komatsu</li> <li>- Marathon</li> <li>- Moxy</li> <li>- Terex</li> <li>- Volvo BM</li> </ul>

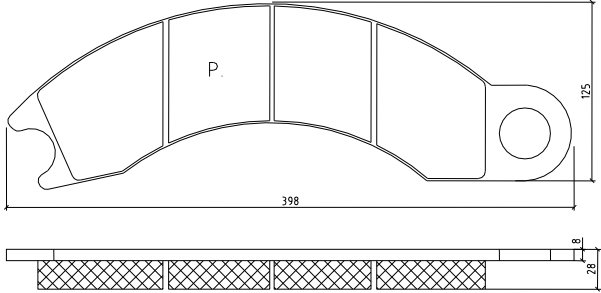
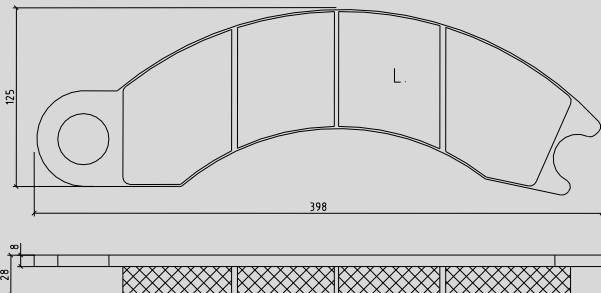
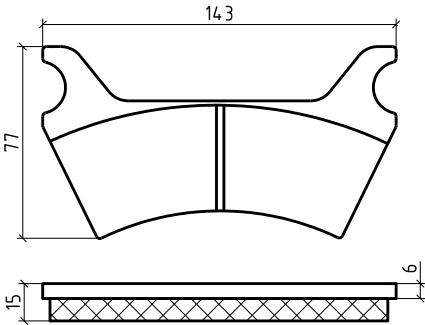
12.	<p>wkładka ciarna prawa nr kat. H1P 1300345 1259878H1 1251177H91 113074C2 1135094C3 1135094C2 4V7062 12969326 566-32-53211 9C0566</p>	 <p style="text-align: center;"><b>Wymiary [mm]</b> 398 x 125 x 28</p>	<ul style="list-style-type: none"> <li>- Benati</li> <li>- Caterpillar 930/950, 950 E Tractor, wozidła przegubowe: 725, 730, D20D, D250B, D250D, D250E, D250EII, D300B, D300D, D300E, D350E, D400E. Skidder: 518, 528, 528B, 530B. ładowarki: 936, 936E, 950B, 950E Scrapers: 613C, 613CII, 613G</li> <li>- Euclid: R35/ R50</li> <li>- Komatsu</li> <li>- Moxly MT36</li> <li>- Wagner</li> <li>- Volvo Excavator</li> </ul>
13.	<p>wkładka ciarna lewa nr kat. H1L 1300346 1259879H1 1251178H91 1135075C2 1135095C3 1135095C2 4V7061 12969325 566-32-53221 9C0567</p>	 <p style="text-align: center;"><b>Wymiary [mm]</b> 398 x 125 x 28</p>	<ul style="list-style-type: none"> <li>- Benati</li> <li>- Caterpillar 930/950, 950 E Tractor, wozidła przegubowe: 725, 730, D20D, D250B, D250D, D250E, D250EII, D300B, D300D, D300E, D350E, D400E. Skidder: 518, 528, 528B, 530B. ładowarki: 936, 936E, 950B, 950E Scrapers: 613C, 613CII, 613G</li> <li>- Euclid: R35/ R50</li> <li>- Komatsu</li> <li>- Moxly MT36</li> <li>- Wagner</li> <li>- Volvo Excavator</li> </ul>
14.	<p>wkładka ciarna nr kat. W0045</p>	 <p style="text-align: center;"><b>Wymiary [mm]</b> 143 x 77 x 15</p>	<ul style="list-style-type: none"> <li>- ładowarki teleskopowe Manitou, Manitou 840</li> </ul>

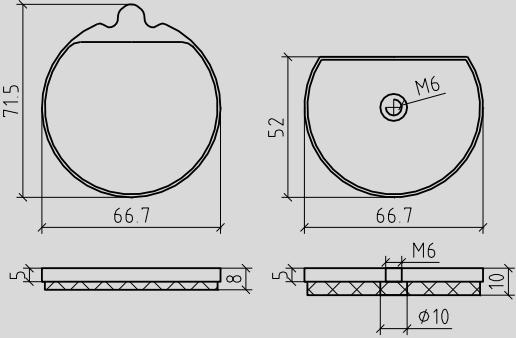
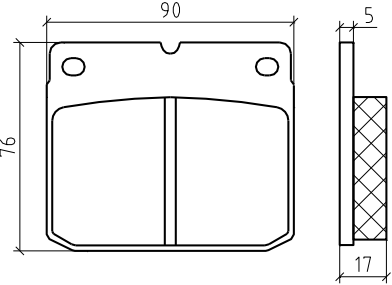
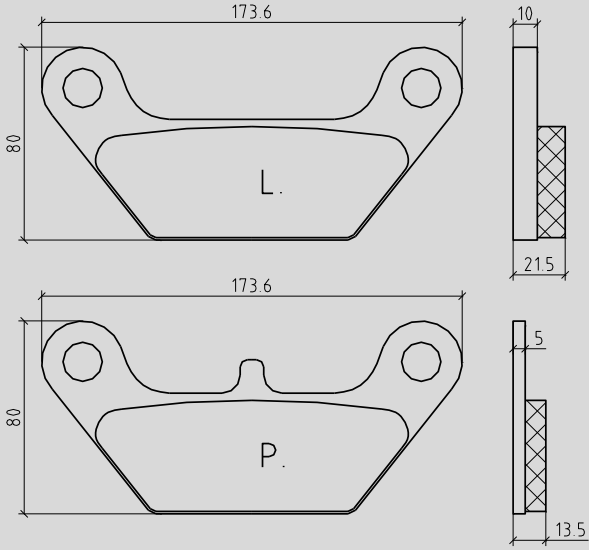
<p>15.</p>	<p>wkładka cierna nr kat. W0050 15/920103</p>	 <p><b>Wymiary [mm]</b> 71,5 x 66,7 x 8 52 x 66,7 x 10</p>	<p>-Koparko-ładowarki: JCB 3CX, 4CX &gt;2001 -ładowarki teleskopowe JCB</p>
<p>16.</p>	<p>wkładka cierna nr kat. W0051 15/920117 15/920396</p>	 <p><b>Wymiary [mm]</b> 90 x 76 x 17</p>	<p>-Ciągniki JCB Fastrac – tylne zaciski 125, 135, 145, 155, 185, 1115, 1125, 1135, 2115, 2125, 2135, 2140, 2150, 2155, 2170, 3155, 3170, 3185, 3190, 3200, 3220, 3230</p>
<p>17.</p>	<p>wkładka cierna nr kat. W0052 476/21218 478/20039 15502439</p>	 <p><b>Wymiary [mm]</b> 173,6 x 80 x 21,5 173,6 x 80 x 13,5</p>	<p>-Ciągniki JCB Fastrac – hamulec ręczny 1115, 1125, 1135, 2115, 2125, 2135, 2150, 3155, 3170, 3185, 3190, 3220</p>

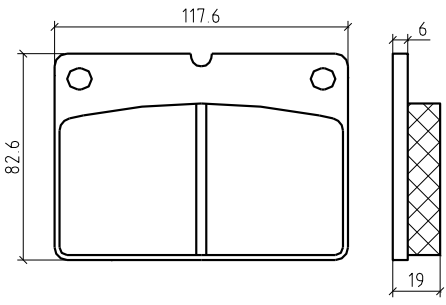
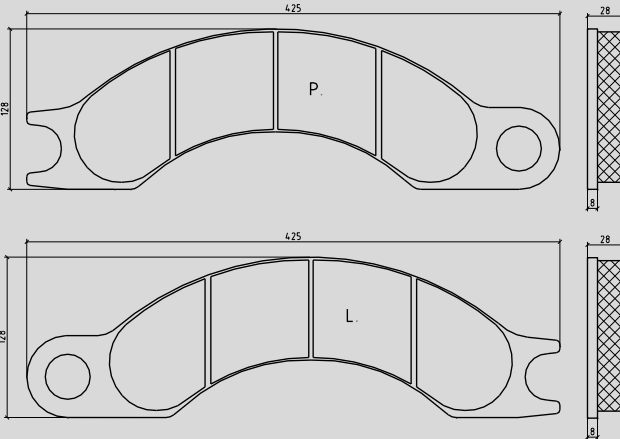
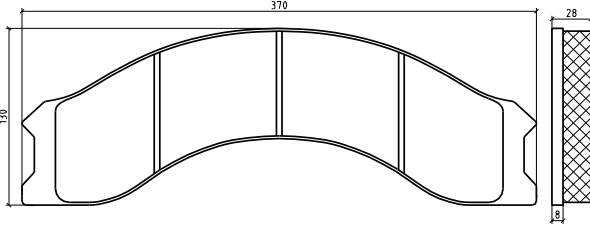
<p>18.</p>	<p>wkładka cierna nr kat. W0053 15/920118 15/920395 477/01006 454-04401</p>	 <p style="text-align: center;"><b>Wymiary [mm]</b> 117,6 x 82,6 x 19</p>	<p>-Ciągniki JCB Fastrac – przednie zaciski Seria 100: 125, 135, 145, 155, 185 125, 135, 145, 155, 185 Seria 1000: 1115, 1125 1115, 1125 -Benati -Ben-Fra</p>
<p>19.</p>	<p>wkładka cierna nr kat. W0054 15501588 15265781 008480510 1K.328.762 MS-15501588</p>	 <p style="text-align: center;"><b>Wymiary [mm]</b> 425 x 128 x 28</p>	<p>- Caterpillar 772 - Terex TA35, TA40 - O&amp;K - Astra - GHH</p>
<p>20.</p>	<p>wkładka cierna nr kat. W0055</p>	 <p style="text-align: center;"><b>Wymiary [mm]</b> 370 x 130 x 28</p>	<p>-Volvo A35, A35D -Aveling Barford -Dresser -Euclid -Michigan</p>

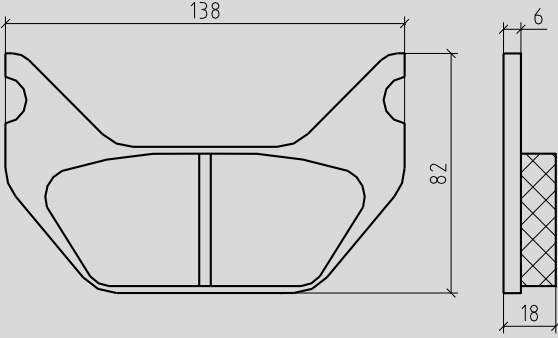
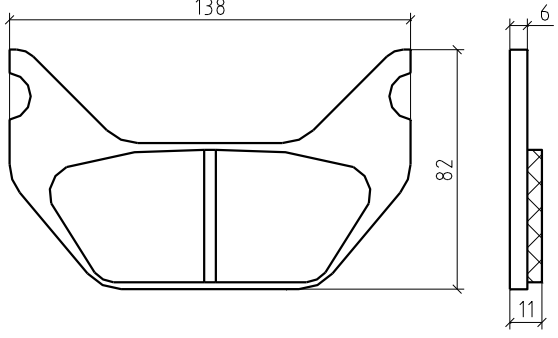
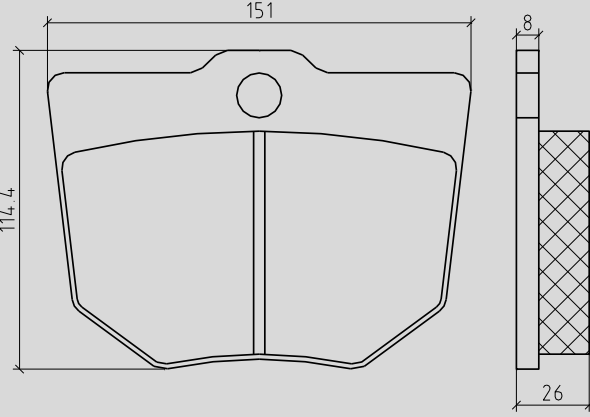

21.	<p>wkładka ciarna</p> <p>nr kat. W0056</p> <p>CASE CNH: 387514A1 76081061 Liebherr: 570528408</p>	 <p style="text-align: center;"><b>Wymiary [mm]</b> 138 x 82 x 18</p>	<p>Ładowarki:</p> <ul style="list-style-type: none"> <li>- Case CNH - 621C, 721C, 721E, 721D, 821C, 821E, 921C, 921E</li> <li>- Daewoo - Mega 300-V</li> <li>- Dossan - DL400</li> <li>- Hyundai - HL 760, HL 770</li> <li>- New Holland - W270B CNH</li> </ul> <p>Równiarka:</p> <ul style="list-style-type: none"> <li>- Mista</li> </ul>
22.	<p>wkładka ciarna</p> <p>nr kat. W0057</p> <p>AT143311</p>	 <p style="text-align: center;"><b>Wymiary [mm]</b> 138 x 82 x 11</p>	<p>- John Deere- hamulec ręczny</p>
23.	<p>wkładka ciarna</p> <p>nr kat. W0058</p> <p>WVA: 29626 29626 258 0 4 T457 2962625804T457 2962603</p>	 <p style="text-align: center;"><b>Wymiary [mm]</b> 151 x 114,4 x 26</p>	<p>Ładowarki:</p> <ul style="list-style-type: none"> <li>- Hanomag 44, 66</li> <li>- Liebherr 1025 LTM, 1030 MF</li> </ul> <p>Kaelble SL 20</p> <p>Wozidła:</p> <ul style="list-style-type: none"> <li>- Perlini</li> </ul>

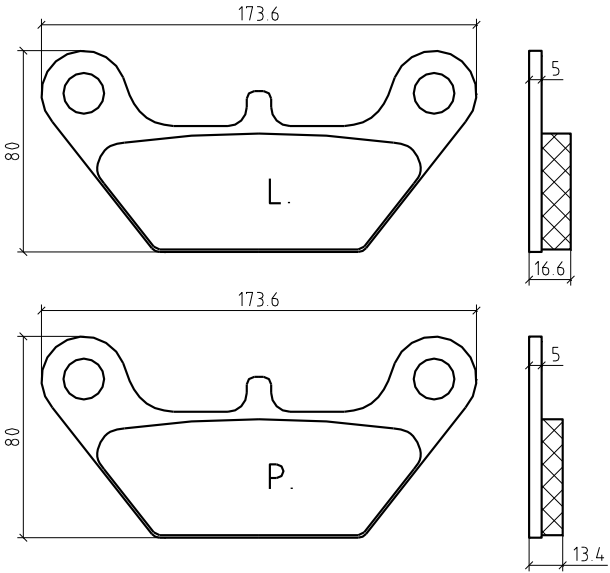
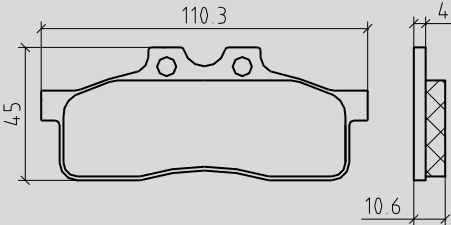
24.	<p>wkładka cierna</p> <p>nr kat. W0059</p> <p>15502439</p>	 <p style="text-align: center;"><b>Wymiary [mm]</b></p> <p style="text-align: center;">173,6 x 80 x 16,6 173,6 x 80 x 13,4</p>	<p>Wozidła:</p> <p>- Terex TA30 – hamulec ręczny &gt;2006r.</p>
25.	<p>wkładka cierna</p> <p>nr kat. W0060</p> <p>9969115 87309170 286000A1 11716655 1271665 2385273 2303810 2590128 564763</p> <p>CA0048646 (Komatsu)</p>	 <p style="text-align: center;"><b>Wymiary [mm]</b></p> <p style="text-align: center;">110,3 x 45 x 10,6</p>	<p>ładowarki, koparko-ładowarki, ładowarki teleskopowe – hamulec ręczny</p> <p>- Caterpillar: 416B, 416C, 416D, 426C, 428B, 428B2, 428C, 428D1, 432E, 436C</p> <p>- Case: 580 SR, 590 SR, 695SR, 695SM, ładowarki teleskopowe TX, ładowarki-321, 421B</p> <p>- Fiat Kobelco/Hitachi - B110, B200, FB110, FB110.2, FB200, FB200.2</p> <p>- Komatsu WB93R-5E0</p> <p>- Manitou</p> <p>- Merlo</p> <p>- NEW HOLLAND: 555/575/655/675 E FB 90/90.2/100/100.2 FB 110/110.2/200/200.2 NH 75/85/95 LB 75/75.B/85/90/90.B/95/95.B LB 110/110.B/115/115.B B 95/100/110/200, B90.B, B100.B, B110.B, B115.B</p> <p>(z blaszką rozpierającą)</p>

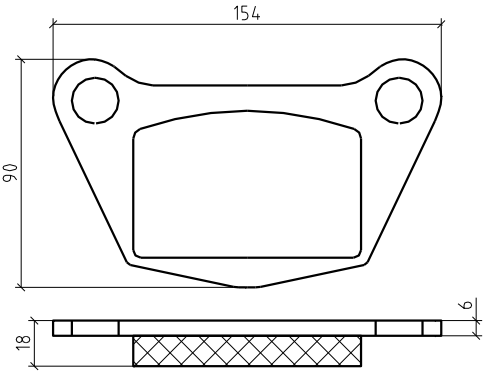
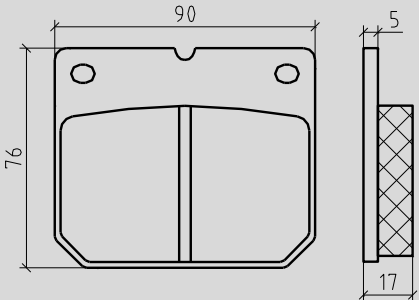
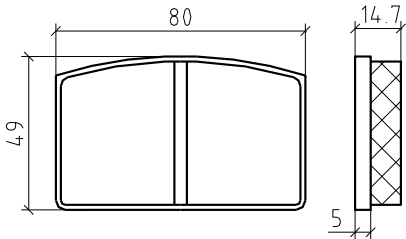
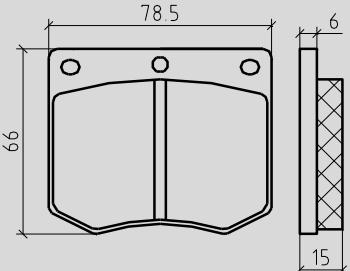
<p>26.</p>	<p>wkładka ciarna nr kat. W0061 04379591 04360093</p>	 <p style="text-align: center;"><b>Wymiary [mm]</b> 154 x 90 x 18</p>	<p>Ciągniki Deutz-Fahr: - Agrocompact: 3.50S, Agrocompact 3.70V/F, Agrocompact 3.90F, Agrocompact 3.90S - Agroextra 3.57, Agroextra 4.07, Agroextra 4.17 - DX3.10SC, DX3.30SC, DX3.50SC, DX3.60SC, DX3.65SC, DX3.70SC, DX3.80SC, DX3.90SC, - DX3.10V, DX3.30V/F, DX3.50S, DX3.50V/F, DX3.70V/F, DX3.90F, DX3.90S - DX3.10VC, DX3.30VC, DX3.50VC, DX3.60VC, DX3.65VC, DX3.70VC, DX3.75VC, DX3.90VC - DX4.07, DX4.11, DX4.17</p>
<p>27.</p>	<p>wkładka ciarna nr kat. W0062</p>	 <p style="text-align: center;"><b>Wymiary [mm]</b> 90 x 76 x 17</p>	<p>Ciągniki New Holland</p>
<p>28.</p>	<p>wkładka ciarna nr kat. W0063 100313A1</p>	 <p style="text-align: center;"><b>Wymiary [mm]</b> 80 x 49 x 14,7</p>	<p>Ładowarka – hamulec ręczny - Case 921B</p>
<p>29.</p>	<p>wkładka ciarna nr kat. W0064 F284100070131 F284100080130 1964205C1 3401145R1 3401146R1</p>	 <p style="text-align: center;"><b>Wymiary [mm]</b> 78,5 x 66 x 15</p>	<p>Ciągniki: - Fendt – seria Favorit: 600 611LS, 611LSA, 611S, 611SA, 612LSA, 612SA, 614LSA, 614SA, 615LSA - Case IH: 1255, 1255XL, 1455, 1455XL Koparki: - Komatsu PW 30</p>

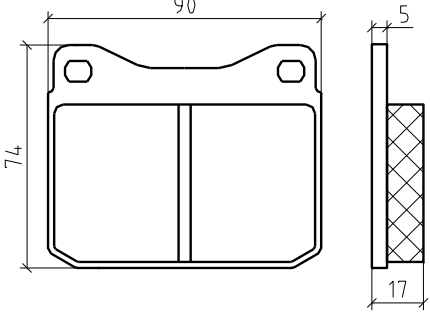
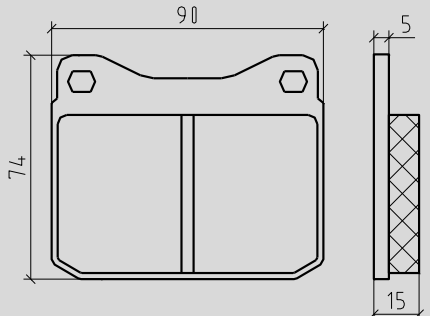
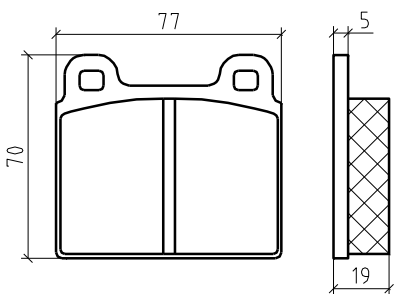
30.	<p>wkładka cierna</p> <p>nr kat. W0065</p>	 <p style="text-align: center;"><b>Wymiary [mm]</b> 90 x 74 x 17</p>	<ul style="list-style-type: none"> <li>- Ben-Fra</li> <li>- Laverda</li> <li>- Venier</li> </ul>
31.	<p>wkładka cierna</p> <p>nr kat. W0066</p> <p>AZ36452 04350837 04377345 04377943 04314064</p>	 <p style="text-align: center;"><b>Wymiary [mm]</b> 90 x 74 x 15</p>	<p>Ciągniki Deutz-Fahr:</p> <ul style="list-style-type: none"> <li>- DX110, DX110A, DX120, DX120A, DX85, DX85A, DX90, DX90A</li> <li>- DX92, DX92A, DX3.70SC, DX3.90SC, DX3.10VC, DX3.30VC</li> <li>- DX3.50VC, DX3.60VC, DX3.70VC, DX3.90VC</li> <li>- DX4.10, DX4.30, DX4.50, DX4.70, DX6.05</li> </ul> <p>Kombajn JOHN DEERE:</p> <ul style="list-style-type: none"> <li>- 965, 965H, 968H, 1065, 1068H, 1169, 1169H</li> </ul>
32.	<p>wkładka cierna</p> <p>nr kat. W0067</p> <p>04378840 04344644 04349608</p>	 <p style="text-align: center;"><b>Wymiary [mm]</b> 77 x 70 x 19</p>	<p>Ciągniki Deutz-Fahr:</p> <p>Intrac 2004, DX 80, 86, 4.10, 4.30, 4.50, 4.70, 6.05, 3.10 VC, 3.10 SC, 3.30 VC, 3.30 SC, 3.50 VC, 3.50 SC, 3.60 SC, 3.65 SC, 3.70 VC, 3.70 SC, 3.75 VC, 3.90 VC, 3.90 SC, AgroPrima 4.51, AgroCompact 3.30 V/F, 3.50 S, 3.50 V/F, 3.70 V/F, 3.90 F, 3.90 S</p>

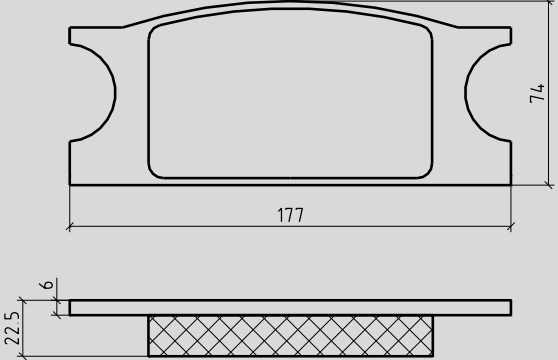
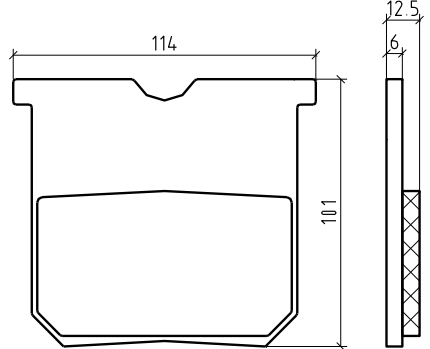
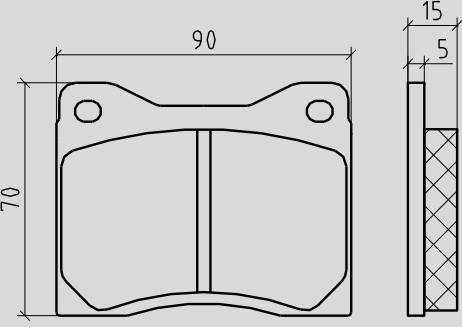
<p>33.</p>	<p>wkładka ciarna nr kat. W0071  11991354 11992695 3V5465 244-736 840472</p>	 <p style="text-align: center;"><b>Wymiary [mm]</b> 177 x 74 x 22.5</p>	<ul style="list-style-type: none"> <li>- Case w14</li> <li>- Caterpillar 910-920, 950, IT12,613,613B</li> <li>- Furukawa FL 330</li> <li>- JCB 2 D - 3 CD, 423</li> <li>- ładowarki volvo bez BM</li> <li>Volvo LM1240,</li> <li>Volvo 4300</li> <li>Volvo G610B - G720B - G726B - G730B - G740B - G746B - G780B - L60E - L70E - L70F</li> <li>- L90D - L90F</li> </ul>
<p>34.</p>	<p>wkładka ciarna nr kat. W0072  CAT 1801160 L8084 31 244-7852 62-3587 L544 L564 04246396 Volvo 11708883</p>	 <p style="text-align: center;"><b>Wymiary [mm]</b> 114 x 101 x 12.5</p>	<ul style="list-style-type: none"> <li>- Monitou MT 1440</li> <li>- Case 330</li> <li>- hamulec ręczny Liebherr L580</li> <li>- hamulec ręczny Volvo: L60 E/F, L70 E/F, L90 D/F G , 700 B</li> <li>G610B, G720B, G726B, G730B, G740B, G746B, G780B, L60E, L70E, L70F, L90D, L90F</li> <li>- BELL</li> <li>- Doosan</li> <li>- Hyundai</li> <li>- JCB</li> </ul>
<p>35.</p>	<p>wkładka ciarna nr kat. W0073  935023</p>	 <p style="text-align: center;"><b>Wymiary [mm]</b> 90 x 70 x 15</p>	<ul style="list-style-type: none"> <li>- Zetor Forterra</li> <li>- Zetor 7520 - 10540</li> </ul>